

Geared motor program

Instruction manual

Document version 1.1

1	GENERAL INFORMATION	3
1.1	DOCUMENTS MODIFIED SCHEDULE	4
1.2	SAFETY INSTRUCTIONS	5
1.3	TECHNICAL DATA	6
1.4	FUNCTION	6
1.5	INSTALLATION	7
1.6	DEFINITION OF QUALIFIED PERSONNEL	7
2	FITTING AND COMMISSIONING THE GEAR UNIT	7
3	FITTING AND COMMISSIONING OF THE MOTOR.....	9
3.1	DC MOTORS	9
3.2	CAPACITOR MOTOR	10
3.3	THREE PHASE MOTOR	14
3.4	EC-MOTOR	17
3.5	LUBRICATION.....	20
3.6	BRAKES	20
4	OTHERS	23
4.1	DEGREE OF PROTECTION	23
4.2	TRANSPORT AND STORAGE	24
4.3	DISPOSAL.....	24
4.4	MAINTENANCE	24
4.5	GUARANTEE, LIABILITY EXEMPTION AND COPYRIGHT	25
	GUARANTEE CARD	27

1. General information

Thank you for buying this geared motor. Please observe:

1. Carefully unpack the geared motor and check content for completeness and damages. Inform your supplier immediately of any damage or other irregularities.
2. Thoroughly read the operating instructions paying attention to detail and ensure that each operator of the geared motor has read the instructions before commissioning.
3. Leave the operating instructions at a place readily accessible to everyone.
4. If after reading the operating instructions there are still some questions regarding the installation, operation, or servicing then please get in contact with our sales department at the following address:

Heidrive GmbH
Starenstraße 23
93309 Kelheim
Germany

Tel.: 0049 -9441/ 707-0
Fax: 0049- 9441/ 707-257
E-Mail: info@heidrive.de
Internet: www.heidrive.de

1.1 Documents modified schedule

Version	Date	Machining method /Modified section	Reviser
1.0	26.03.2013	Changing on Heidrive	Perzl
1.1	06.05.2015	Correction of spelling on page 10	Zauner

1.2 Safety instructions



Danger!

Indicates that death or severe personal injury will result if proper precautions are not taken.



Warning!

Indicates that death or severe personal injury can result if proper precautions are not taken.



Caution!

Indicates that minor personal injury can result if proper precautions are not taken.



Attention!

Indicates that property damage can result if proper precautions are not taken.



Danger voltage!

Adverts special hazards of electrical voltage. Indicates that death, severe or minor personal injury, property damage can result if proper precautions are not taken.



Don't beat the shaft!



The gear units are designed to handle the values and loads specified on the label and in the order confirmation and catalogue. For safety reasons the gear units may only be used for applications for which they are planned, taking into account the application factor. An overload can lead to damage or destruction of the gearbox. Changes to the drive are not authorized unless with prior approval from us. The geared motors in the standard model are designed to operate with an ambient temperature of 0°C - +40°C. To operate the drive outside the specified temperature range the drive must first be modified and changed at our factory. Installation is possible up to a max. of 1000 m above sea level (NN).



Warning!

To avoid danger from free rotating gear unit shafts, appropriate safety devices must be installed.

The gear unit is not self-locking. During fitting work on the holding brake or brake motor in connection with lifting processes, the relevant safety regulations for working under overhung loads must be observed.



Caution!

When in operation do not touch the gearbox casing with bare hands. Depending on the operating temperature of the drive, you may suffer burns. Use gloves to protect your hands!



Warning!

Do not operate the drive in very damp or humid facilities without taking the necessary measures (see also chapter: “degree of protection”, page 23). Do not operate in facilities where there is a danger of explosion.



The electrical and mechanical assemblies don't need to be manipulated.



The safety equipment must not be disabled or otherwise changed in any way which contravenes the regulations.



Warning!

Execution of installation work is only authorized provided that this is carried out by qualified technical personnel, that there is no risk of violent pressure or slipping, that the motors are disconnected from mains power and secured against accidental switching-on, that original parts are used, and that workers use insulated tools. All cables, terminal boards, etc. must be switched to be free of voltage.



Do not hit the gear shaft or motor shaft.



To avoid overheating in the whole drive, care should be taken to ensure an free air circulation. The fan cowl must not be covered or modified.

1.3 Technical data

You can find the specifications for the geared motor on the label, the attached order confirmation, the invoice and in the Heidrive catalogue. The dimensions can be found in the dimension sheets in the catalogue.

1.4 Function

Heidrive helical gear units are 2 or 3 stage and reduce the high input speed of the motor to the required slower gear unit output speed. The input torque of the motor is thereby multiplied with the gearratio (reduced by the friction torque of the gear). This increased torque is on the output shaft.

Heidrive helical bevel gear units are 3 stage and in addition to the bevel wheel stage they have a helical stage before and after. The input shaft is arranged offset to the output shaft by 90°. The bevel stage with curved gears enables a low backlash.

1.5 Installation

Installation and connection of the drive must be done by qualified personnel. The relevant safety regulations for the prevention of accidents must be observed. The geared motor has protection class IP 54, or optionally IP 65. The exact protection class is specified on the label. Please also read the chapter: "Degree of Protection", page 23. Operation in outside conditions or in very humid rooms is not authorized without appropriate measures. Do not operate the unit in rooms where there is a risk of explosion. If the geared motor is operated above drinking water, foods, etc., then appropriate measures must be taken, e.g. special lubrication.

The ambient temperature at the installation site should be 0° to + 40°C. Installation height max. 1000 m above sea level. The drive must be fitted so that there is sufficient air circulation to enable heat exchange.

1.6 Definition of qualified personnel

In the sense of this instruction manual or warning instructions on the product itself qualified personnel are persons who are familiar with the installation, mounting, commissioning and operation of the product and who possess the appropriate qualifications for their job e.g.:

- a) Qualification or instruction respectively with authorization to connect electric circuits and devices, to switch devices on and off, to earth devices, and to label devices according to the standards of safety engineering.
- b) Qualification or instruction according to the standards of safety engineering to service and use the appropriate safety equipment.
- c) First aid training.

2 Fitting and commissioning the gear unit

Remove the protection cap from the shaft.

The drive may only be fitted in the installation position as ordered. If the installation position changes, then the gear unit (e.g. amount of filled oil) must be adjusted in our factory. For installation positions please see the catalogue. Please contact our technical sales department if you have any questions.

Thoroughly remove any possible protective coating against corrosion from the shaft ends. For this you can use a solvent readily available in the trade and take care that the solvent does not go into the bearing or seal since otherwise there could be damage to materials.

Ventilation for the gear unit is not necessary with Heidrive gears. The gear units do not have vent screws or drain plugs and are lubricated for the life of the gear unit; a lubrication during the service life is not necessary. The gear units are therefore maintenance-free.

The gear unit must be mounted or screwed in a stable way to a level and rigid surface in order to avoid tension in the gearbox casing or the shaft end bearing.

Foot-mounted versions partly require packing since the radius of the cover is partly bigger than the shaft height.

Caution: Make sure you avoid hammering to the output shaft since otherwise the life of the bearings may be significantly reduced.

Before commissioning the drive ensure

- that the drive is not damaged,
- that it is correctly connected as it should be,
- that all protection and safety devices are installed (including trial operation),
- that possible necessary safety covers are fitted,
- that the drive does not run against the block,
- that possible mounted brakes should be released,
- that the rotation of the drive is correct (see connection diagram) and
- that no other sources of dangers are present.

When fitting elements such as couplings, chain wheels or pulleys, the appropriate fixtures must be available. Never force on couplings, pulleys, pinions, etc. by hitting with a hammer on the end of the shaft. The shaft, gearbox casing and the bearing may be damaged by this. Heating up the shaft counterpart to 100°C is recommended for this job. Please observe the manufacturer's specifications regarding the prestress on chains and wheels. Do not exceed the max. forces (for values see the catalogue). Additionally mounted transfer elements must not cause excessive radial or axial forces. The input and output elements, pulleys, couplings, etc. must be covered with a guard. The shaft ends have a feather key and feather key slot (DIN 6885).

With helical bevel gears which have a hollow shaft and feather key connection the slip-on gear unit is pushed onto the drive shaft of the machine to be driven. The reaction torque must be supported either by a flange on the gear unit or through a torque arm. With a flange attachment the flange connection surface on the machine must not exceed a right angle deviation to the shaft axis by 0.03 mm since otherwise the danger of tension on the bearing or excessive bending loads on the machine shaft may arise.

The hollow shaft bore is machined to tolerances according ISO h⁷ and feather key slot according to DIN 6885. The machine shaft must be ISO h⁷. The machine shaft should have a centering thread according to DIN 332. To pull the gear unit onto the machine shaft, the machine shaft should first be lightly coated with MoS₂ paste. The hollow shaft and the feather key slot should be lightly covered with slushing oil and the gear unit pulled on using the central screw. *Caution:* Do not hit with a hammer. Never push on the gear unit in a dry state since otherwise in the case of a repair pulling it off again will be hindered or made impossible by rust (frictional corrosion). If you encounter tightly fitted shafts when disassembling we recommend you allow penetrating oil to take effect for a fairly long time at the end of the shaft in the snug fit.

3 Fitting and commissioning of the motor

In the factory the motors are fitted to the gear unit. The electrical connections must be carried out by qualified technical personnel and correspond to the valid regulations. The connection takes place in the terminal box. The connection plan is located in the inside lid of the terminal box. The technical data for the motor can be found on the nameplate. When connecting the motor please check for the correct cross section of the cables. Please check whether the terminal links are correctly arranged and that the connections and protective conductor are firmly screwed on. The mains voltage and mains frequency must be the same as the specifications listed on the nameplate.

3.1 DC-Motor

The technical data of the motor is written on the label (tolerance +/- 5%). The guarantee becomes invalid if the unit is used in an inappropriate manner.

The electrical connection between the motor and power supply unit must only be made by qualified personnel. With motors the torque must not be exceeded by a factor of three since otherwise there will be a demagnetization of the stators. Corresponding protection measures in the form of electronic assemblies or start-up current limiter must be provided. All non-insulated connecting elements (terminals, connectors, etc.) must be insulated or made inaccessible.

The power supply cable for the motor should be laid to take into account the nominal current of the motor so that the current density does not exceed the allowed current according to the standards DIN 100 and VDE 128.

The motor must be protected against overload and short-circuiting. If the motor, due to connected masses, happens to continue to run, then voltage is generated. The power supply at the ends of the motor must be protected against voltage feedback. Due to the regenerative operation at the motor terminals, the electronic assemblies must be equipped with correspondingly dimensioned protection devices.

In steady operation when geared motors with 24V without electronics are used note that the motor may draw too high current. Please ensure that the maximum armature current is not exceeded since otherwise the magnets in the motor can be damaged. The maximum rated currents are listed in the motor specification table. We recommend that for these motors controllers are used with current limiters in order to avoid unacceptably high armature currents. When operating without a controller (with 24V) we recommend using starting resistors.

Motor type	Power	I max.	Voltage
350	45 W	13 A	24 V DC
351	100 W	27,7 A	24 V DC
352	150 W	41,7 A	24 V DC
353	300 W	78 A	24 V DC
354	500 W	16,5 A	180 V DC

Motor operation in both rotation directions is possible. The change of direction is achieved by polarity reversal.

Maintenance:

The carbon brushes should be checked after each 500 hours of operation. To do this first disconnect the motor from the mains power. Open the brush holder, pull out the brushes and use compressed air to blow out with a max. of 2 bar pressure. If the minimum length of the brushes (see table) is reached, the set should be completely replaced by new carbon brushes.

Minimum length of the carbon brushes

Motor type	Power	Minimum length
350	45 W	6 mm
351	100 W	9 mm
352	150 W	9 mm
353	300 W	9 mm
354	500 W	9 mm

Motors with brakes

All brakes mounted to the motors (optional) are holding brakes. The brakes can hold the motor in the standstill position, but cannot brake dynamically. The required voltage is listed on the label. If this voltage is not reached, it may be possible that the brake only partly opens or doesn't release at all.

3.2 Capacitor motor

A thermostat/thermal contact (ÜHS = thermal protection) is integrated in the winding of the motor. This is normally connected in the terminal box and must be used as a thermal protection for motors. The thermal contact is lead through the insulating screw joint in the terminal box and must be used for fuse protection, whereby in cases of motor overheating it must be ensured that all phases are disconnected.

A capacitor is necessary to operate the motor, and as standard the capacitor is not included in delivery. The capacitor values and dimensions are listed in the table.

Motor type	P2 [W]	L1 [mm]	L2 [mm]	∅d1 [mm]	∅d2 [mm]	Cap.* [μF]	Voltage [V]
203.60-4	20	8	69	M8	30	5	400
203.50-2	30	10	81	M8	25	4	400
211.55-2	80	8	74	M8	30	8	400
235.30-4	20	8	69	M8	30	5	400
235.40-4	40	8	79	M8	30	6	400
235.40-4	60	10	99	M8	30	8	400
235.55-4	90	10	99	M8	35	10	400
263.45-4	120	10	99	M8	40	12	400
263.60-4	180	10	119	M8	40	16	400
271.50-4	250	10	124	M8	45	25	400
271.65-4	370	12	164	M12	50	30	400
271.90-4	550	12	164	M12	55	40	400

2xx.xx-2 = 2-poles 2xx.xx-4 = 4-poles
* Values at 50 Hz

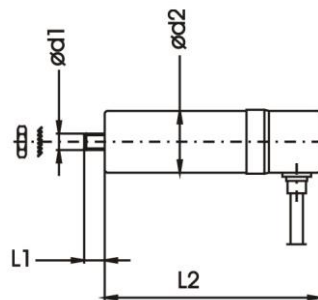

Heidrive capacitor motors are equipped with a terminal box. The capacitor motors are connected to the phase L1 and N of a single phase. The mains voltage must match the voltage requirement of the motor (see label). The rotation direction can be changed from clockwise to anti-clockwise by exchanging the conductors (see connection plan). In the terminal box there is a protective PE terminal intended for grounding.

The brake must always be externally supplied with 230VAC 50/60Hz. In the connector version the brake rectifier is connected via the connectors. In the version with conduit thread the customer must supply the brake rectifier directly. There is a separate screwed gland reserved for this in the conduit thread version.

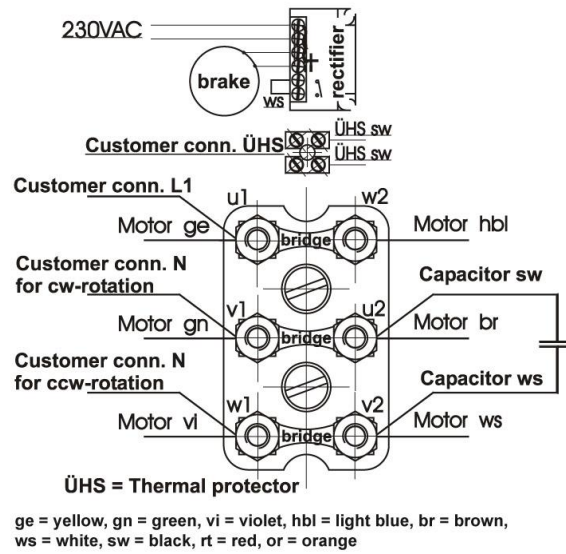

Danger! Disconnect the motor from the main power !

**Capacitor motor
1 ~ 230 V**

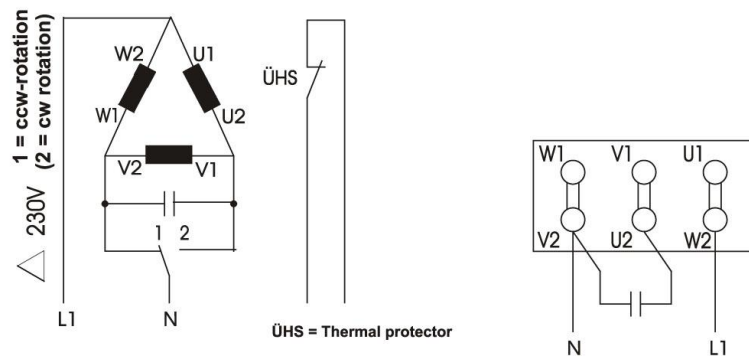

Connection diagram for heavy current plug

Capacitor motor ccw-/cw-rotation, 230 V/50/60 Hz

A	Brake	230VAC	ws
B	Brake	230VAC	ws
C	ÜHS		sw
D	ÜHS		sw
1	U1	L1	ge
2	PE		gnge
3	W1	N (CCW)	vi
4	V1	N (CW)	gn

ÜHS = Thermal protector
ws=white, sw=black, ge=yellow,
gn=green, vi=violett

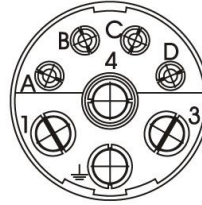

Leads cross section:
A - D : $0,5^2 - 0,75^2$
1 - 4 : $0,5^2 - 1^2$

Connection diagram for signal plug with encoder HRI

HRI-Encoder/ EC-Motor

1	ÜHS	only EC	sw
2	ÜHS	only EC	sw
3	RLE HS3	only EC	ws
4	RLE HS2	only EC	br
5	RLE HS1	only EC	vi
6	RLE U+	only EC	rt
7	RLE GND	only EC	hbl
8	Photo-Trans.	Emitter	rt
9	Photo-Trans.	Kollektor	or
10	LED	Anode	sw
11	LED	Kathode	br
12			

ÜHS = Thermal protector
RLE = Hall sensor
sw=black, ws=white, br=brown, vi=violett,
rt=red, hbl=light blue, or=orange

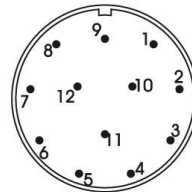

Leads cross section:
1-16 : $0,14 - 0,56$

PIN 1-7 will not be used when connecting to a capacitor motor.

Connection diagram for signal plug with encoder HP

HP-encoder/EC-motor

1	ÜHS	only EC	sw
2	ÜHS	only EC	sw
3	RLE HS3	only EC	ws
4	RLE HS2	only EC	br
5	RLE HS1	only EC	vi
6	RLE U+	only EC	rt
7	RLE GND	only EC	hbl
8	encod.chan.A	optional	gr
9	encod.chan.B	optional	ge
10	encod.chan.1	optional	gn
11	encod.+5VDC	optional	or
12	encod. GND	optional	sw

ÜHS = Thermal protector
RLE = Hall sensor
sw=black, ws=white, br=brown, vi=violett,
rt=red, hbl=light blue, gr=grey, ge=yellow,
gn=green, or=orange

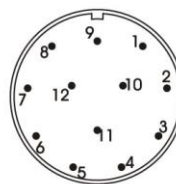

Leads cross section:
1-16 : $0,14 - 0,56$

PIN 1-7 will not be used when connecting to a capacitor motor.

Connection diagram for signal plug with encoder Hengstler

With Hengstler-encoder/
Three phase-/Capacitor Motor

1			
2			
3	Encoder A		bl
4	Encoder \bar{A}		bl/sw
5	Encoder B		gn
6	Encoder \bar{B}		gn/sw
7	Encoder Z		vi
8	Encoder \bar{Z}		vi/sw
9	Encoder	shield	--
10	Encoder GND		sw
11	Encod.+5VDC		rt
12			

bl=blue, sw=black, gn=green,
vi=violett, rt=red

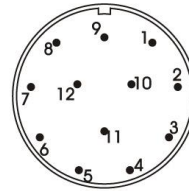

Leads cross section:
1-16 : 0,14 - 0,56

3.3 Three phase motor

A thermostat/thermal contact (ÜHS=Überhitzungsschutz = Thermal protector) is integrated in the winding of the motor. This break is connected in the terminal box and must be used as a thermal protection for motors. The thermal contact is lead through the insulating screw joint in the terminal box and must be used for fuse protection, whereby one must ensure that in the case of a motor overheating all phases are disconnected.

Heidrive three phase motors are fitted with a terminal box. They are connected via three phases L1, L3, L2 to a three phase mains power system. The mains voltage must be the same as the voltage designed for the motor (see label). The direction of rotation can be changed from counter-clockwise to clockwise by changing two phases. In the terminal box there is a protective-conductor terminal intended for earthing. In accordance with the VDE guidelines there must be a protective earthing for the motor.

Heidrive three phase motors can be operated at 3 ~ 230 V as well as 3 ~ 400 V. The voltage change is made by reconnecting from delta to star connection (see circuit diagram). The three phase motors are suitable for use with frequency converters. In operation with a frequency converter the brake must be separately supplied with power from one connection (using a cable gland or power connector).

The brake must always be externally supplied with 400VAC, 50/60Hz. In the connector version the brake rectifier is connected across the connectors. In the version with conduit thread the customer must supply the brake rectifier directly. There is a separate screwed gland reserved for this in the conduit thread version. When operating with Δ 230 the brake recitifer must be exchanged.

△ 230VAC = is not delivery version

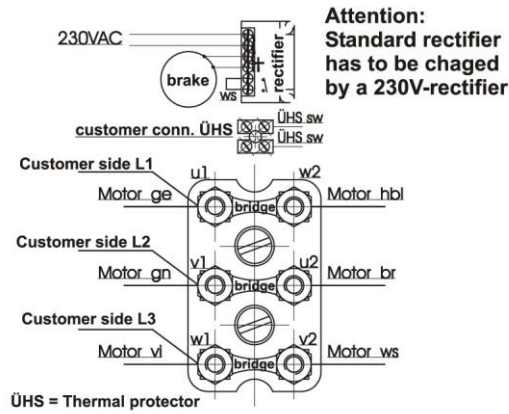

**Y400VAC Standardversion=
Delivery version**

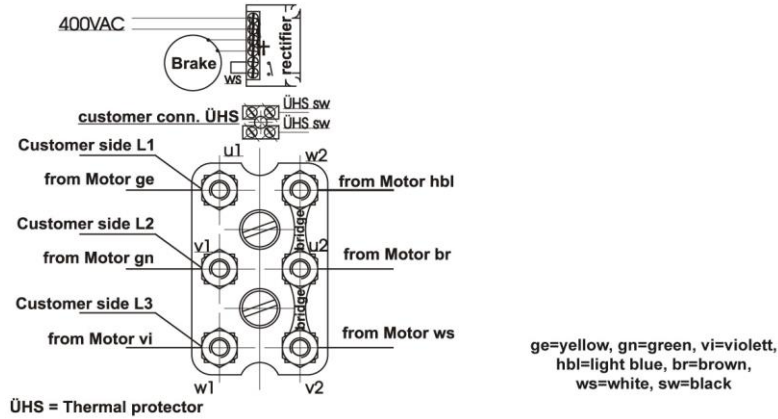

Danger! Disconnect the motor from the main power !

△ 230 V

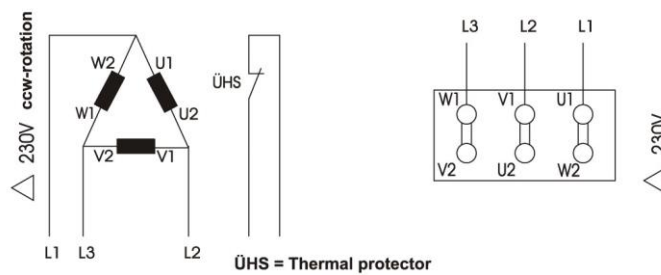

Y 400 V

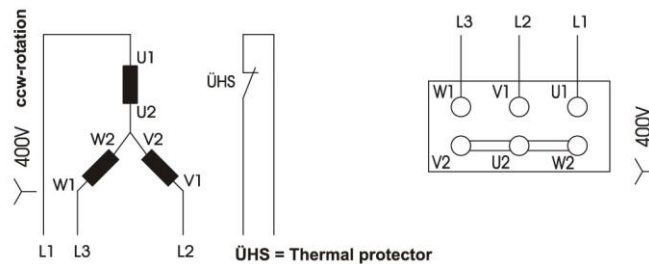

Danger! Disconnect the motor from the main power !

Connection diagram for heavy current plug

Three phase motor
ccw-rotation
 Δ 230V Y400V
50 / 60 Hz

A	brake	400VAC	ws
B	brake	400VAC	ws
C	ÜHS		sw
D	ÜHS		sw
1	U1	L1	ge
2	PE		gnge
3	W1	L3	vi
4	V1	L2	gn

ÜHS = Thermal protector

at Δ 230 V brake supply must be 230V
and please use rectifier for 230 V



Leads cross section:

A - D : $0,5^2 - 0,75^2$
1 - 4 : $0,5^2 - 1^2$

With Δ 230 V the brake must be supplied with 230 V and a different rectifier must be used.

Connection diagram for signal plug with encoder HRI

HRI-Encoder/
EC-Motor

1	ÜHS	only EC	sw
2	ÜHS	only EC	sw
3	RLE HS3	only EC	ws
4	RLE HS2	only EC	br
5	RLE HS1	only EC	vi
6	RLE U+	only EC	rt
7	RLE GND	only EC	hbl
8	Photo-Trans.	Emitter	rt
9	Photo-Trans.	Kollektor	or
10	LED	Anode	sw
11	LED	Kathode	br
12			

ÜHS = Thermal protector
RLE = Hall sensor
sw=black, ws=white, br=brown, vi=violett,
rt=red, hbl=light blue, or=orange

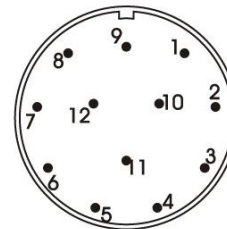

Leads cross section:

1-16 : $0,1^2 - 0,5^2$

PIN 1-7 will not be used when connecting to a three phase motor.

Connection diagram for signal plug with encoder HP

HP-encoder/EC-motor

1	ÜHS	only EC	sw
2	ÜHS	only EC	sw
3	RLE HS3	only EC	ws
4	RLE HS2	only EC	br
5	RLE HS1	only EC	vi
6	RLE U±	only EC	rt
7	RLE GND	only EC	hbl
8	encod.chan.A	optional	gr
9	encod.chan.B	optional	ge
10	encod.chan.1	optional	gn
11	encod.+5VDC	optional	or
12	encod. GND	optional	sw

ÜHS = Thermal protector
RLE = Hall sensor
sw=black, ws=white, br=brown, vi=violett,
rt=red, hbl=light blue, gr=grey, ge=yellow,
gn=green, or=orange

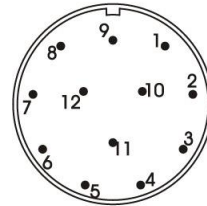

Leads cross section:
1-16 : 0,1²⁴ - 0,5²⁶

PIN 1-7 will not be used when connecting to a three phase motor.

Connection diagram for signal plug with encoder Hengstler

With Hengstler-encoder/ Three phase-/Capacitor Motor

1			
2			
3	Encoder A		bl
4	Encoder A		bl/sw
5	Encoder B		gn
6	Encoder B		gn/sw
7	Encoder Z		vi
8	Encoder Z		vi/sw
9	Encoder	shield	--
10	Encoder GND		sw
11	Encod.+5VDC		rt
12			

bl=blue, sw=black, gn=green,
vi=violett, rt=red

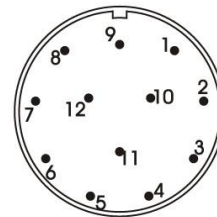

Leads cross section:
1-16 : 0,1²⁴ - 0,5²⁶

PIN 1-7 will not be used when connecting to a three phase motor.

3.4 EC Motor

The overheating protection (thermal contact) is connected to PIN 1 and 2 of the signal connector and must be used for protection, whereby in the case of a motor overheating it is necessary to ensure that all phases are disconnected (see also wiring diagram of a connected electronic).

Due to small mass moments of inertia and high start torque the motors have a very good dynamic response. *Note:* Please observe the max. torque of the adapted gear unit. To make sure that the max. rated torque of the gear unit is not exceeded, it is possible to limit the current or torque via the current setting of the electronic assembly.

The EC (electronically commutated) motors are equipped with Hall sensors which give a signal for the status of the magnets. This signal is evaluated by the electronics and via a digital control regulates the power semiconductors. By

changing the rotation frequency, a change of speed is realised. Connecting an encoder enables a higher accuracy of the reported speed.

The EC motor is fitted with a signal and a power connector. The ÜHS (thermostat), the rotor position recognition, and possibly also the encoder, are connected to the signal connector. The motor connections, PE cable, and possibly an external switch for the brake, are connected to the power connectors.

The electronics are powered by either 230 V AC or 24 V DC.

The connection cable between the motor and electronics or motor and mains power isn't included in delivery, but can be assembled and purchased as an option. The cable must be shielded.

Connection is made on the motor via a power connector and a signal connector which are led to a terminal box.

The motors are demagnetizing-proof in connection with the corresponding electronic assemblies.

Connection diagram for heavy current plug

EC-motor (brushless DC)
ccw-/cw-rotation
230V 50/60 Hz
24VDC

A	brake	230VAV/24VDC	ws	(like motor voltage)
B	brake	230VAV/24VDC	ws	(like motor voltage)
C				
D				
1	U1		ge	
2	PE		gnge	
3	W1		vi	
4	V1		gn	

ws=white, ge=yellow,
gn=green, vi=violett

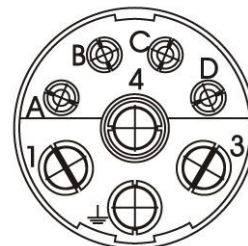

Leads cross section:

A - D : 0,5² - 0,75²

1 - 4 : 0,5² - 1²

Connection diagram for signal plug with encoder HRI

HRI-Encoder/ EC-Motor

1	ÜHS	only EC	sw
2	ÜHS	only EC	sw
3	RLE HS3	only EC	ws
4	RLE HS2	only EC	br
5	RLE HS1	only EC	vi
6	RLE U±	only EC	rt
7	RLE GND	only EC	hbl
8	Photo-Trans.	Emitter	rt
9	Photo-Trans.	Kollektor	or
10	LED	Anode	sw
11	LED	Kathode	br
12			

ÜHS = Thermal protector
RLE = Hall sensor
sw=black, ws=white, br=brown, vi=violett,
rt=red, hbl=light blue, or=orange

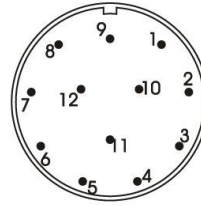

Leads cross section:
1-16 : 0,14 - 0,56

Connection diagram for signal plug with encoder HP

HP-encoder/EC-motor

1	ÜHS	only EC	sw
2	ÜHS	only EC	sw
3	RLE HS3	only EC	ws
4	RLE HS2	only EC	br
5	RLE HS1	only EC	vi
6	RLE U±	only EC	rt
7	RLE GND	only EC	hbl
8	encod.chan.A	optional	gr
9	encod.chan.B	optional	ge
10	encod.chan.1	optional	gn
11	encod.+5VDC	optional	or
12	encod. GND	optional	sw

ÜHS = Thermal protector
RLE = Hall sensor
sw=black, ws=white, br=brown, vi=violett,
rt=red, hbl=light blue, gr=grey, ge=yellow,
gn=green, or=orange

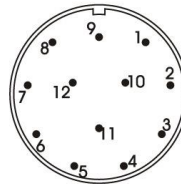

Leads cross section:
1-16 : 0,14 - 0,56

Connection diagram for signal plug with encoder Hengstler

With Hengstler-encoder/ EC-motor

1	ÜHS		sw
2	ÜHS		sw
3	RLE HS3	only EC	ws
4	RLE HS2	only EC	br
5	RLE HS1	only EC	vi
6	RLE U±	only EC	rt
7	RLE GND	only EC	hbl
8	Encoder A		bl
9	Encoder A		bl/sw
10	Encoder B		gn
11	Encoder B		gn/sw
12	Encoder Z		vi
13	Encoder Z		vi/sw
14	Encoder	shield	--
15	Encoder GND		sw
16	Encod.+5VDC		rt

ÜHS = Thermal protector
RLE = Hall sensor
sw=black, ws=white, br=brown, vi=violett,
rt=red, hbl=light blue, bl=blue, gn=green

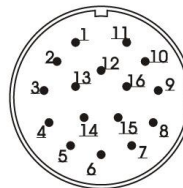

3.5 Lubrication

The geared motors are supplied with high performance mineral oil and ready for immediate use. On request and as an optional extra gear units can be filled with synthetic oil suitable for special ambient conditions. Special measures should be taken where ambient temperatures deviate from the allowed range for standard lubricant (0 - +40°C) and in this case please contact the Heidrive technical service department.

The gear units have no vent screws or drain plugs and are lubricated for the life of the gear unit; lubrication during the service life is not necessary. The gear units are therefore maintenance-free.

3.6 Brakes

The brakes FWB 53 (1.5 Nm, 8.5 W) and FWB 57 (2 Nm, 9 W) - see label - can only be operated as holding brakes, i.e. they may only be operated after the motor has stopped. These brakes are not suitable for positioning tasks. A certain number of emergency stops is possible. The number of emergency stops depends on the energy to be absorbed. The brakes for EC motors are also only suitable for use as holding brakes. All other brakes can also be used for dynamic braking. With applications where brakes are used for dynamic braking, the characteristic load value of the gear unit must be observed. Depending on the frequency of operation, an increase of the load characteristic value must be allowed for.

All brakes must be externally supplied with current and are not switched on the terminal board.

For motors with plug design the brake connection must always be taken up via the power connector.

Motors which have a cable screwed gland/conduit thread must have the brake connection made directly at the rectifier.

For the operation of three phase motors with frequency converter it should be taken into account that the converter voltage is not suitable to isolate the brake. For operation with a delta 230 V connection the brake rectifier must be exchanged.

Motor type	Power	Brake type	Braking torque	Braking power	Power supply of the brake
	[W]		[Nm]	[W]	[V] DC
Capacitor- and three phase motor					
203.50-2	30	FWB 53	1,5	8,5	190
203.60-4	20	FWB 53	1,5	8,5	190
211.55-2	80	FWB 57	2	9	190
235.30	20	FDB06	0,5	13,5	190
235.40	40	FDB06	0,5	13,5	190
235.40	60	FDB06	1	13,5	190
235.55	90	FDB06	2	13,5	190
263.45	120	FDB08	2,5	22	190
263.60	180	FDB08	2,5	22	190
271.50	250	FDB08	4	22	190
271.65	370	FDB08	5	22	190
271.90	550	FDB08	5	22	190
EC-Motors					
315.50	60	FWB53	1,5	8,5	24/190
316.30	95	FWB57	2	9	24/190
317.55	220	FDB06	2	13,5	190
318.60	300	FDB08	5	22	190

Brake switching times

Size/model	Braking torque	t1	t2=	t2~
	[Nm]	[ms]	[ms]	[ms]
FDB08	5	35	30	70
FDB08	4	25	60	70
FDB08	2,5	20	80	70
FDB06	2	30	40	85
FDB06	1	15	70	85
FDB06	0,5	10	100	85
FWB53	1,5	30	20	45
FWB57	2	30	20	45

t1 = turn on time (release time)

t2 = break time with DC operated switching (fall time)

t2~ = break time with AC operated switching (fall time)

Connection brake at Capacitor motor

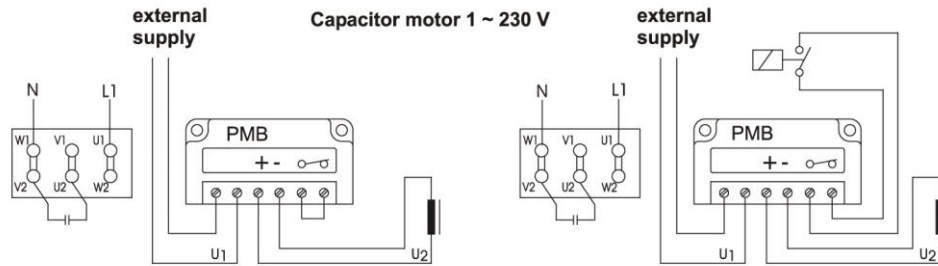

Connection brake at three phase motor 3~230 V

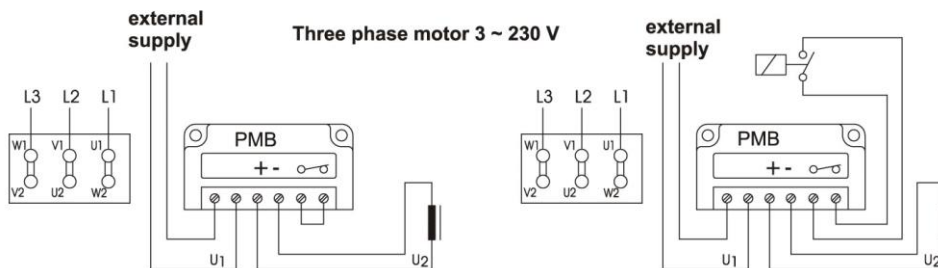

Connection brake at three phase motor 3~400 V

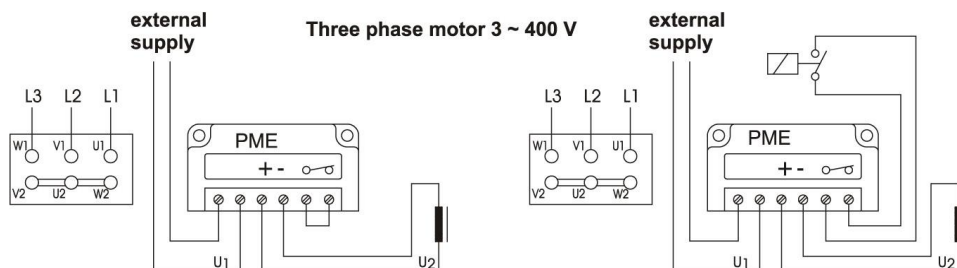

The brakes are supplied externally.

In the conduit thread version there is a cable screwed gland.

In the connector version the brake rectifier is connected to the power connector (see connector plan).

The three phase motors are switched as standard with 400 V star and equipped with a 400 V brake rectifier.

For operation with 230 V delta connection the brake rectifier must be exchanged for a 230 V model.

4 Others

4.1 Degree of protection(according to DIN EN 60529: Sept.2000)

Please note the protection class of the geared motor which is written on the nameplate. The geared motor usually has protection class IP 54 (protection against dust and splash water) or the optional protection class IP 65 (protection against dust and jet-water).

Operation is not authorized in outdoor conditions or in very humid rooms without the appropriate measures. Operation is not allowed in rooms where there is a risk of explosion.

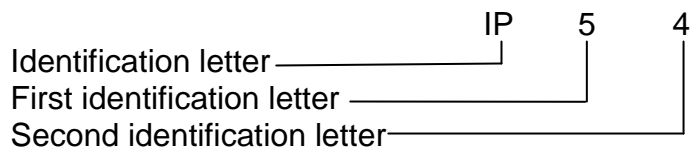

First Index	Protection against accidental contact and foreign bodies
0	No protection
1	Protection against compact foreign bodies ($\varnothing > 50$ mm)
2	Protection against compact foreign bodies ($\varnothing > 12$ mm)
3	Protection against compact foreign bodies ($\varnothing > 2,5$ mm)
4	Protection against dust deposits
5	Protection against ingress of dust
6	

Second index	Protection against water
0	No protection
1	Protection against water drops falling from the vertical
2	Protection against water drops falling (up to 15° from the vertical)
3	Protection against sprayed water (up to 60° from the vertical)
4	Protection against splash water (from all directions)
5	Protection against jet water (from all directions)
6	Protection against flooding (from all directions)
7	Protection against immersion (temporarily)
8	Protection against continuous immersion

4.2 Transport and storage

The drive leaves our factory in a tested and properly packed condition. Despite this after receipt the drive must be immediately examined for damage and completeness (accessories). Please immediately notify your supplier about any possible deviations.

If the drive must be forwarded, then the original packaging - or other suitable packaging - must be used.

When transporting and storing the unit care should be taken that knocks or shocks are avoided.

The drive must be stored at a dry location with minimal temperature fluctuation. In some circumstances high air humidity can lead to corrosion. In storage the drive should be protected against dust and moisture. After a longer storage period it is necessary to check before commissioning whether the terminal box is dry and clean, that screwed cable glands fit snugly and that the connection and fitting parts are free from corrosion.

4.3 Disposal

We advise you to take care that old units or damaged units are disposed of in the appropriate manner at an official collection point. Please note: the gear unit is filled with oil -> dispose of used oil according to the regulations.

Please also dispose of the packaging material according to the environmental regulations (material separation).

4.4 Maintenance

The gear units do not have vent screws or drain plugs and are lubricated for the life of the gear unit; lubrication during the service life is not necessary. The gear units are therefore maintenance-free.

If cleaning is necessary, switch off the drive and disconnect from the mains voltage. Clean the housing and surfaces of the parts with a moist cloth. Do not use chlorine bleaches, cleaning agents based on chlorine, scouring agents, ammonia, cleaning wool or cleaning agents with metallic particles. When using solvents these must not come into contact with the seal lip on the shaft end seal.

! If a repair is necessary, this should always be carried out by a specialist authorized by Heidrive.

! All modifications and repairs to the electrical connection cables should only be carried out by an authorized electrician.

4.5 Guarantee, liability exemption and copyright

Guarantee

The manufacturer's guarantee for the described products (with the exception of wear and tear parts) is 12 months starting from the date of delivery from the manufacturer's warehouse. This guarantee covers defects in materials or defects in the manufacturing of the product.

Damage due to transport are not covered by this guarantee.

Please inform us immediately in the case of a claim on the guarantee. If the case in question is a defect in the material or defect in the manufacturing, then we will either repair or replace the unit so that the unit is operating correctly.

For damage due to inappropriate handling or inappropriate use Heidrive cannot accept any claims on the guarantee.

Any change in this declaration of guarantee requires a written confirmation by Heidrive.

Liability exemption

Heidrive accepts no liability for damage due to external influences or inappropriate handling or inappropriate use.

Heidrive is exempt from liability for any consequential damage or costs.

Copyright

The written approval of the manufacturer is required for permission to reproduce (photocopies, micro-copies) the operating instruction in full or in part or to distribute this information in newspapers, magazines or other media. Transfer to a third party is only authorized by the explicitly written consent of Heidrive GmbH & Co. KG.

This instruction manual may not be given to third parties and may only be made available to authorized personnel.

If after reading the operating instructions there are still some questions regarding the installation, operation, or servicing then please get in contact with our representative or with :

Heidrive GmbH

Starenstraße 23

93309 Kelheim

Germany

Tel. 0049 9441/707-0

Fax 0049 9441/707-257

E-Mail: info@heidrive.de

Internet: www.heidrive.de

Guarantee card

The Heidrive guarantee for the described products is for 12 months starting from the date of the delivery from the manufacturer's warehouse. This guarantee covers defects in materials or defects in the manufacturing of the product. Damage due to transport is not covered by the guarantee. In the case of a claim on the guarantee please immediately inform our plant.

When making a claim on the guarantee please send in the filled-in guarantee card or the sale invoice together with the unit in question and reasons for your claim to our plant. All shipments must be sent to Heidrive with prepaid postage.

UNIT TYPE ACCORDING TO LABEL/ SERIAL NUMBER:
--

DATE OF SALE:

STAMP AND SIGNATURE OF THE PRODUCER:
--

REASONS FOR THE CLAIM:
--

We reserve the right to make technical changes without prior announcement.
No claims will be accepted related to any data, pictures or descriptions
contained in these operating instructions.